

DEPARTMENT OF THE ARMY TECHNICAL BULLETIN

SMOKE POT, HC, 10-lb., M1, and 30-lb., ABC-M5; SMOKE POT, FLOATING, HC, M4A2; SGF2, AN-M7; and SGF2, AN-M7A1 Refs: FM 3-50, FM 5-25; SR 55-730-10; TM 3-215, TM 3250

Headquarters, Department of the Army, Washington, D.C. 6 April 1964

SAFETY PRECAUTIONS

When igniting a smoke pot manually, keep the head well to one side of the top of the pot and out of the way of sparks or flame.

Do not use the pull ring or safety pin on the fuze for lifting or handling smoke pots.

Vent burning-type (HC) floating smoke pots for at least 5 minutes within 24 hours before firing by removing adhesive tape from two vent holes in the inside cover. Recover the holes with adhesive tape before firing smoke pots.

Do not remove the tape covering the smoke-emission holes in thermal generator-type (SGF) smoke pots.

Use a 4- to 6-foot pole when moving a misfired pot immediately following the first ignition attempt. After 5 minutes, the misfired pot can be moved safely by hand.

When authorized to burn smoke pots to prevent enemy use, be sure that smoke from the pots does not interfere with the operations of nearby tactical units.

Wear a protective mask when exposed to a high concentration of HC smoke, when exposed for a prolonged period to an ordinary field concentration of HC, or when exposed for a prolonged period to a high concentration of SGF.

When training with smoke pots, take precautionary measures against accidental fires.

Table with 3 columns: SECTION, Paragraph, Page. Rows include I. INTRODUCTION (Scope, Purpose) and II. GENERAL INFORMATION (Smokes, Difference in models, Methods of firing).

* This bulletin supersedes so much of TM 3-300, 14 August 1956, including C 2, 5 May 1958, C 3, 25 August 1959, and C 5, 24 May 1962, as pertains to smoke pots.

	Paragraph	Page
SECTION II. Misfires -----	6	5
Concealing glare of burning pots -----	7	5
III. BURNING-TYPE SMOKE POTS		
Smoke Pot, HC, 10-lb., M1 -----	8	6
Smoke Pot, HC, 30-lb., ABC-M5 -----	9	8
Smoke-Pot, Floating, HC, M4A2-----	10	9
IV. THERMAL GENERATOR-TYPE SMOKE POTS		
Smoke Pot, Floating, SGF2, AN-M7-----	11	12
Smoke Pot, Floating, SCGF2, AN-M7A1 -----	12	13
Filling and fusing-----	13	13
Ignition -----	14	13
Functioning -----	15	14
V. MARKING AND PACKING		
Marking -----	16	16
Packing -----	17	16
VI. SHIPMENT, STORAGE, AND DEMOLITION TO PREVENT ENEMY USE		
Shipment -----	18	16
Storage -----	19	16
Firefighting -----	20	16
Demolition to prevent enemy use -----	21	16

Section I. INTRODUCTION

1. Scope. This bulletin describes Smoke Pot, HC, 10-lb., M1, and HC, 30-lb., ABC-M5; and Smoke Pot, Floating, HC, M4A2; SGF2, AN-M7; and SGF2, AN-M7A1. It also gives information on their handling, functioning, storage, shipment, and destruction.

2. Purpose. Smoke pots are designed to produce large volumes of screening smoke. Floating smoke pots

can be used either on land or water; the others can be used only on land. For employment of smoke pots, see FM 3-50, Chemical Smoke Battalion and Chemical Smoke Generator Company.

Section II. GENERAL INFORMATION

3. Smokes. Type C HC smoke mixtures and fog oil are the smoke-producing agents (TM 3-215) used in these smoke pots.

a. Type C HC Smoke Mixture. Type C HC smoke mixture (used in the M1, ABC-M5, and M4A2 smoke pots) consists of approximately 47 percent hexachloroethane, 47 percent zinc oxide, and 6 percent grained aluminum.

b. Fog Oil. Fog oil is a petroleum oil used to fill AN-M7 SGF2 and AN-M7A1 SGF2 floating smoke pots (thermal generator smoke pots). Depending on the operating temperature (table I), two grades are used. SGF1, which has approximately the same viscosity as SAE 40 motor oil, is used when the operating temperature is above 90° F. SGF2, which has approximately the same viscosity as SAE 10 motor oil, is used when the operating temperature is 0° F. to 90°F. If the operating temperature is below 0° F., kerosene is added to dilute the SGF2.

Table I. Filling for Thermal Generator Smoke Pots

Operating temperature (°F.)	Recommended filling
Above 90	SGF1
Zero to 90	SGF2
Zero to -25	3 parts SGF2, 1 part kerosene
-26 to -40	Equal parts SGF2, 1 and kerosene

4. Difference in Models. *a.* Smoke pots are essentially portable steel containers filled with a smoke-producing agent. An essential difference between land-type smoke pots and floating

Table II. Smoke Pots

Smoke pot	Container size- (in.)	Filling		Ignition method	Weight (lb.) (approx.)	Delay time (sec.)	Burning time (min.)	Shipping			
		Weight (lb.) (approx.)	Material					Type of container	Units per container	Ship- ping weight (lb.)	Cubage (cu. ft.) (approx.)
Smoke Pot, HC, 10-lb., M1.	9 by 5.5 dia.	10	Type C. HC smoke mixture	Matchhead and scratcher block. ¹	12.5	10	5-8	Wood box	3	48	0.9
Smoke Pot; HC, 30-lb., ABC-M5.	9.5 by 8.5 dia.	31	Type C HC smoke mixture.	Matchhead and scratcher block or electrical.	33	20-30	12-22	Wood box	1	47	1.1
Smoke Pot, Floating, HC, M4A2	13 by 12 dia.	27.5	Type C HC smoke mixture.	M207A1 smoke pot fuze.	38	10-20	10-15	Wood box Steel drum	1 1	47 48	2.0 2.1
Smoke Pot, Floating, SGF2, AN-M7.	13 by 12 dia.	² 13	⁴ SGF2	M208 smoke pot fuze or M209 electric smoke pot fuze.	³ 26.5	8-20	8-13	None	—	³ 26.5	1.5
Smoke Pot, Floating, SGF2, AN-M7A1.	13 by 12 dia.	² 13	⁴ SGF2	M208 smoke pot fuze or M209 electric smoke pot fuze.	⁵ 25.5	8-20	8-13	None	—	⁵ 25.5	1.5

¹ May be modified for electric firing.

² Shipped unfilled and w/o fuze.

³ Filled weight, 40 lb.

⁴ Filling for normal temperatures. See table II for hot- and cold-weather fillings.

⁵ Filled weight, 39 lbs.

smoke pots lies in the ratio of total bulk of the smoke pot to bulk of smoke-producing agent. Floating smoke pots are not completely filled with agent; voids in the container permit the pots to float in water.

b. For ease of presentation, the smoke pots covered in this bulletin will be considered as burning type (those filled with HC smoke mixtures) or thermal generator type (those filled with SGF fog oil).

c. Specific data on the smoke pots described in this bulletin are given in table II.

5. Methods of Firing. a. *Single Ignition.* Smoke pots can be ignited singly by using the means of ignition supplied with each pot. The M1 smoke pot is designed for manual ignition but may be modified for electric ignition. The ABC-M5 smoke pot has an integral electric ignition device in addition to a friction igniter and can be ignited either manually or electrically. Floating smoke pots are ignited by igniting fuzes. Two of the floating smoke pots, the AN-M7 and the AN-M7A1, can be fitted with M209 electric smoke pot fuzes for electric ignition. Circuits and connections for electric ignition are the same as for demolitions (FM 5-25).

b. *Multiple Ignition.* When a number of M1 or ABC-M5 smoke pots must be ignited simultaneously at different locations, they can be prepared for electric ignition and connection into an electric firing circuit as described in FM 5-25 and in paragraphs 8c and 9c. The AN-M7 and AN-M7A1 floating smoke pots can also be ignited electrically in multiple when the M209 fuze is used.

c. *Chain Ignition.* A number of M1 or ABC-M5 smoke pots can be arranged to ignite in succession, thus providing smoke for a longer period than is possible using a single pot. To accomplish chain ignition, the pots can be placed in stacks (fig. 1) and the topmost pot in the stack ignited, or they can be laid on their sides (fig. 2) end to end and the pot with the exposed igniting device ignited. Prior to stacking, the outer covers must be removed from all pots so that the igniting devices are exposed. When M1 smoke pots are stacked vertically, supports must be provided for stability. The ABC-M5 smoke pot is especially designed for vertical stacking, and because the bottom of one pot fits snugly into the top of the one below it, no support is required. Whether pots are stacked vertically or laid on their sides, the heat generated by one burning pot in a series ignites the

adjacent pot. The total burning time of a series of smoke pots ignited by chain ignition is slightly less than the sum of the individual burning times, because each pot ignites shortly before

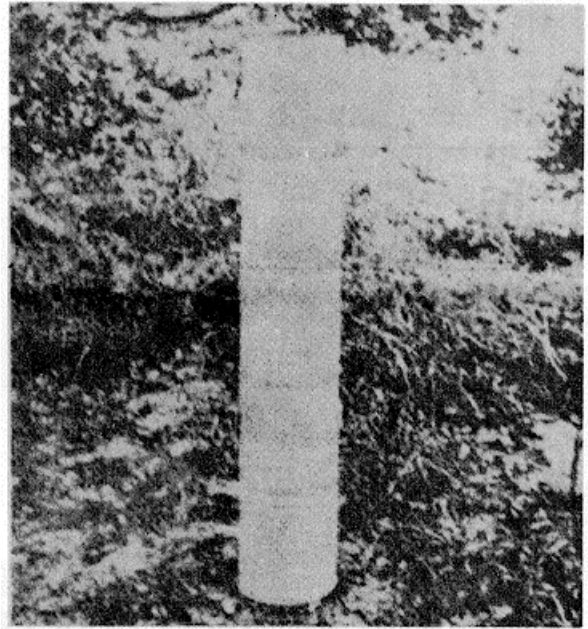

Figure 1. ABC-M5 smoke pots stacked vertically.

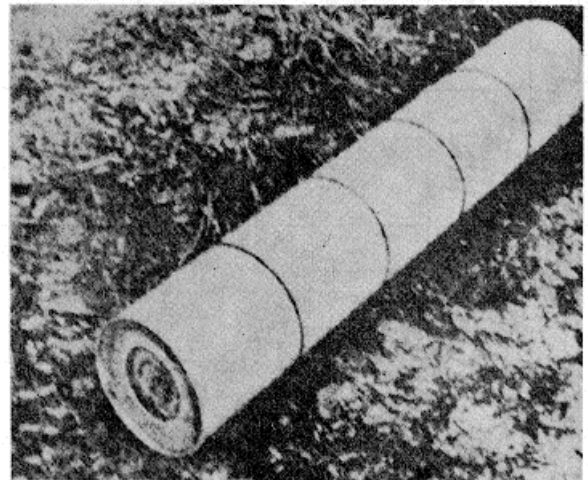

Figure 2. ABC-M5 smoke pots laid end to end.

the pot ignited previously is completely burned out.

6. Misfires. HC smoke pots which have misfired during normal ignition can be ignited by placing the ignition device in the misfired pot next to a burning pot and igniting the misfired pot by chain ignition (par. 5c).

Warning: Use a 4- to 6-foot pole when moving a misfired pot immediately following the first ignition attempt. After 5 minutes, the misfired pot can be moved safely by hand.

7. Concealing Glare of Burning Pots. When the tactical situation requires that the glare from a burning smoke pot be concealed, a shield must be improvised. The shield must permit the smoke to escape freely while concealing the glare given off by the pot. The burning pot can be placed under a 55-gallon drum (A, fig. 3) or in a covered trench (B, fig. 3) or the glare can be

concealed by other field expedients. Neither the 55-gallon drum nor the trench will completely screen the light from the burning pots. Further, when a burning smoke pot is inclosed in a shield, slightly less smoke is produced than from an unshielded pot; hence compensation must be made for the reduction in smoke by the use of additional smoke pots.

a. *5.5-Gallon-Drum Method (A).* Cut a 14-inch-diameter hole in the center of one head of the drum and a 6-inch-diameter off-center hole in the other head. Place the drum on blocks over smoke pot.

b. *Covered-Trench Method (B).* Dig a trench, 3 1/2 feet long, 1 foot wide, and 3 feet deep. Place the smoke pot on its side in the trench and cover the trench with available materials, such as wood from packing boxes. Leave two 6-inch-wide openings for emission of the smoke.

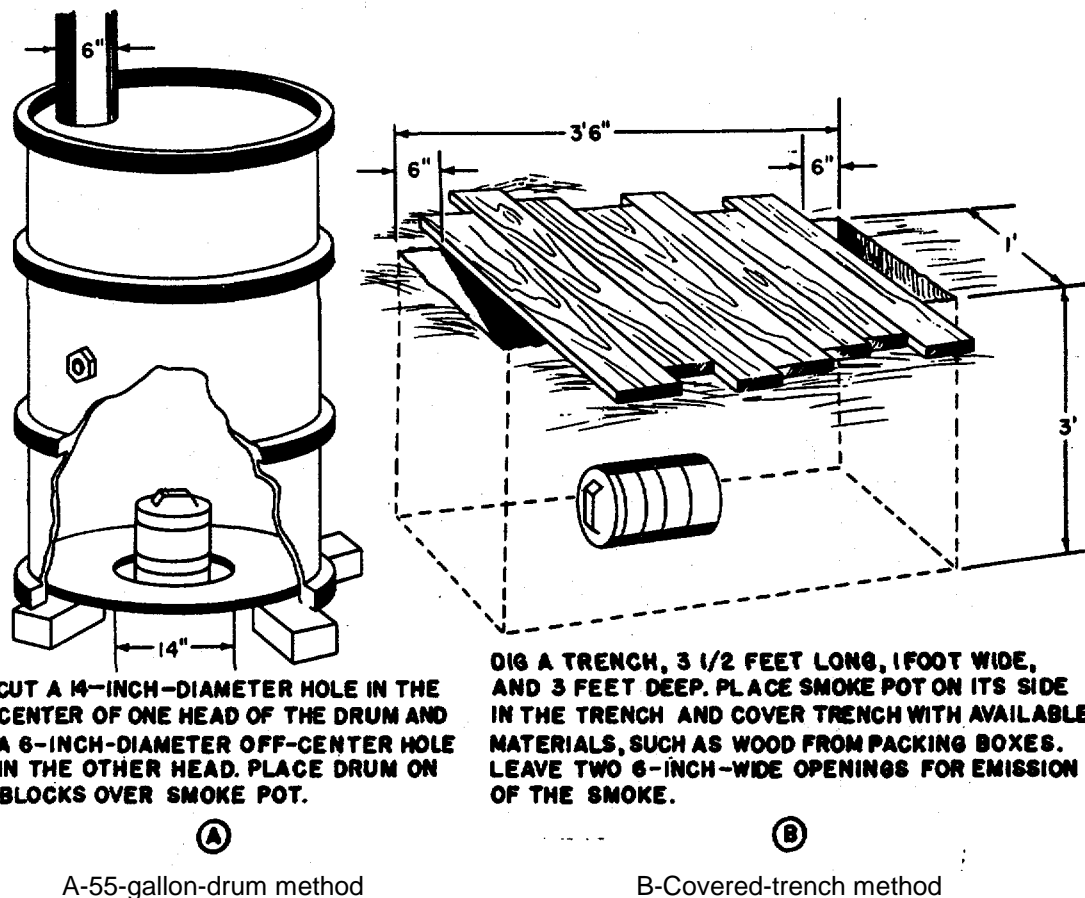

Figure 3. Methods of concealing glare from burning smoke pots.

Section III. BURNING-TYPE SMOKE POTS

8. Smoke Pot, HC, 10-lb., M1. a. Description.

The M1 smoke pot (fig. 4) is a cylindrical sheet-metal container, 5 1/2 inches in diameter by 9 inches high, filled with approximately 10 pounds of type C HC smoke mixture and provided with an ignition device. A removable outer cover, which protects the contents during storage and shipment, is clamped to the top of the pot by a metal clamp and is sealed with adhesive tape. A nonremovable inner cover with a hole in its center covers the filling. A plastic cup containing a starter mixture is embedded in the filling directly under the hole in the inner cover. A matchhead is centered in the hole in the inner cover in contact with the starter mixture. A scratcher block in a paper envelope is packed between the outer and inner covers.

b. Manual Ignition.

- (1) *Single.* To prepare an M1 smoke pot for manual ignition, strip off the adhesive tape and clamp. Remove the outer cover to expose the matchhead and take the scratcher block from its envelope. To ignite, draw the scratcher block rapidly across the matchhead. The matchhead ignites the starter mixture which in turn ignites the HC filling. After a delay of approximately 10

seconds, smoke is produced for 5 to 8 minutes.

- (2) *Chain.* Remove the outer covers from the required number of pots, stack the pots vertically, or lay them end-to-end horizontally and ignite one pot.

c. Electric Ignition (fig. 5).

- (1) An M1 flash-vented electric squib is used to ignite the M1 smoke pot electrically. (This squib is not a component of the M1 smoke pot; it is issued separately.) To ignite the pot, connect the lead wires from the squib to a source of electric current.
- (2) To prepare the M1 smoke pot for electric ignition, remove the tape, clamp, and cover (A). Remove the sealing compound using the clamp as a scraper (B). Place a squib beside the matchhead with one hole in the squib facing the matchhead (C). Cover the squib

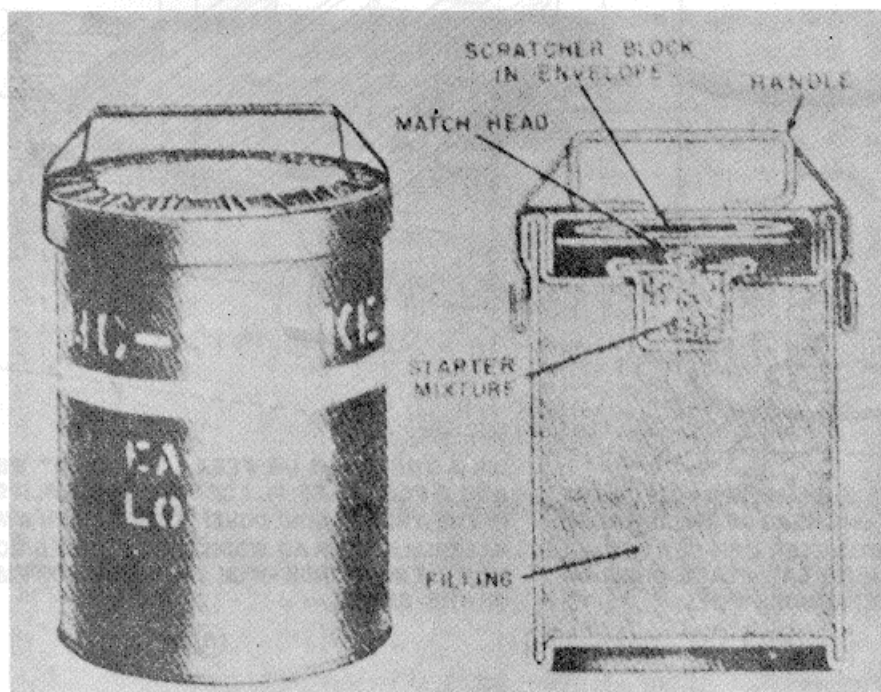
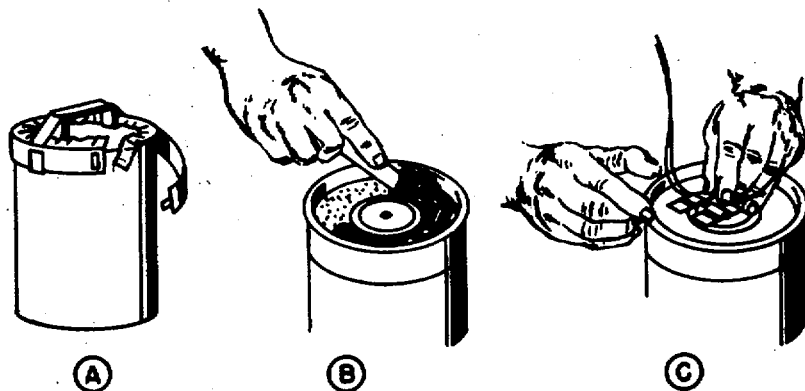
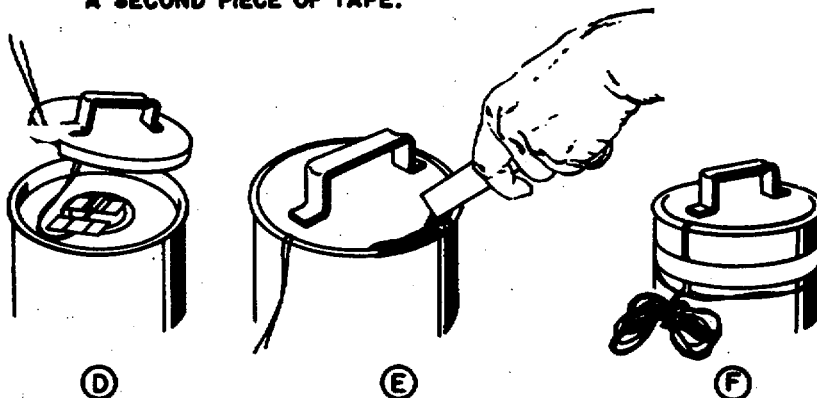

Figure 4. M1 10-lb. HC smoke pot.



- (A)** REMOVE TAPE, CLAMP, AND COVER. **(B)** REMOVE SEALING COMPOUND USING CLAMP AS SCRAPER. **(C)** PLACE SQUIB BESIDE MATCHHEAD WITH ONE HOLE IN SQUIB FACING MATCHHEAD. COVER SQUIB AND MATCHHEAD WITH PIECE OF WATERPROOF TAPE WHICH WAS REMOVED FROM COVER. TAPE SQUIB LEAD WIRES TO COVER WITH A SECOND PIECE OF TAPE.



- (D)** MAKE A SHALLOW DENT IN LIP OF COVER; THEN PRESS COVER FIRMLY IN PLACE ALLOWING SQUIB LEAD WIRES TO PASS UNDER DENT. **(E)** SEAL JUNCTION BETWEEN POT AND COVER WITH SEALING COMPOUND USING CLAMP AS AN APPLICATOR. **(F)** MAKE A HALF HITCH AROUND POT WITH SQUIB LEAD WIRES. FASTEN CLAMP AROUND POT ABOVE HALF HITCH TO HOLD WIRES IN PLACE.

Figure 5. Preparing MI smoke pot for electric ignition.

and matchhead with a piece of the waterproof tape which was removed from the cover. Tape the squib lead wires to the cover with a second piece of tape (C). Make a shallow dent in the lip of the cover (D) ; then press the cover firmly in place allowing the squib lead wires to pass under the dent. Seal the junction between the pot and the cover with sealing compound using the clamp as an applicator (E). Make a half hitch around the pot with the squib lead wires and fasten the clamp around the pot above the half hitch to hold wires in place (F).

9. Smoke Pot, HC, 30-lb., ABC-M5. a.

Description. The ABC-M5 smoke pot (figs: 6 and 7) is a cylindrical sheet-metal container, 8 1/2 inches in diameter by 9 1/2 inches high, filled with approximately 30 pounds of type C HC smoke mixture and 1 pound of fast-burning smoke mixture. The bottom of the container is tapered to a diameter of 8 1/4 inches to permit stable stacking. The pot is covered by a non-removable outer cover with a circular tear strip. Two binding posts, which are mounted on the outer cover, are connected internally by two lead wires to two electric squibs. A carrying handle is mounted on the outer cover. An inner cover with a

circular hole in its center covers the filling. A plastic cup containing a starter mixture is embedded in the top of the filling under the hole in the inner cover. A matchhead which is centered above the starter mixture is accessible when the tear strip is removed. A scratcher block in a paper envelope is packed between the inner and outer covers.

b. *Manual Ignition.*

(1) *Single.* Expose the matchhead by pulling the tear strip handle upward and move the scratcher block quickly across the matchhead. Flame from the matchhead travels to the starter mixture which in turn ignites the HC filling. After a delay of 20 to 30 seconds, smoke is produced for 12 to 22 minutes.

(2) *Chain.* Remove tear strips from all pots; then stack the pots (par. 5c) by fitting the bottom of one into the top of the next. When the stack is complete, ignite the end pot.

c. *Electric Ignition.* ABC-M6 smoke pots can be ignited singly or in multiple by electric ignition. To prepare for electric ignition, connect wires from the power source to the binding

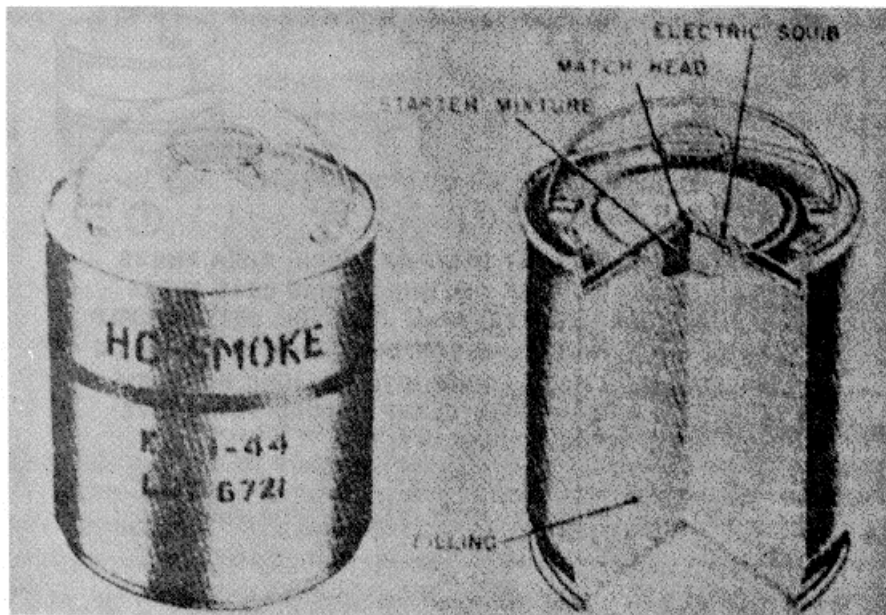

Figure 6. ABC-M5 30-lb. HC smoke pot.

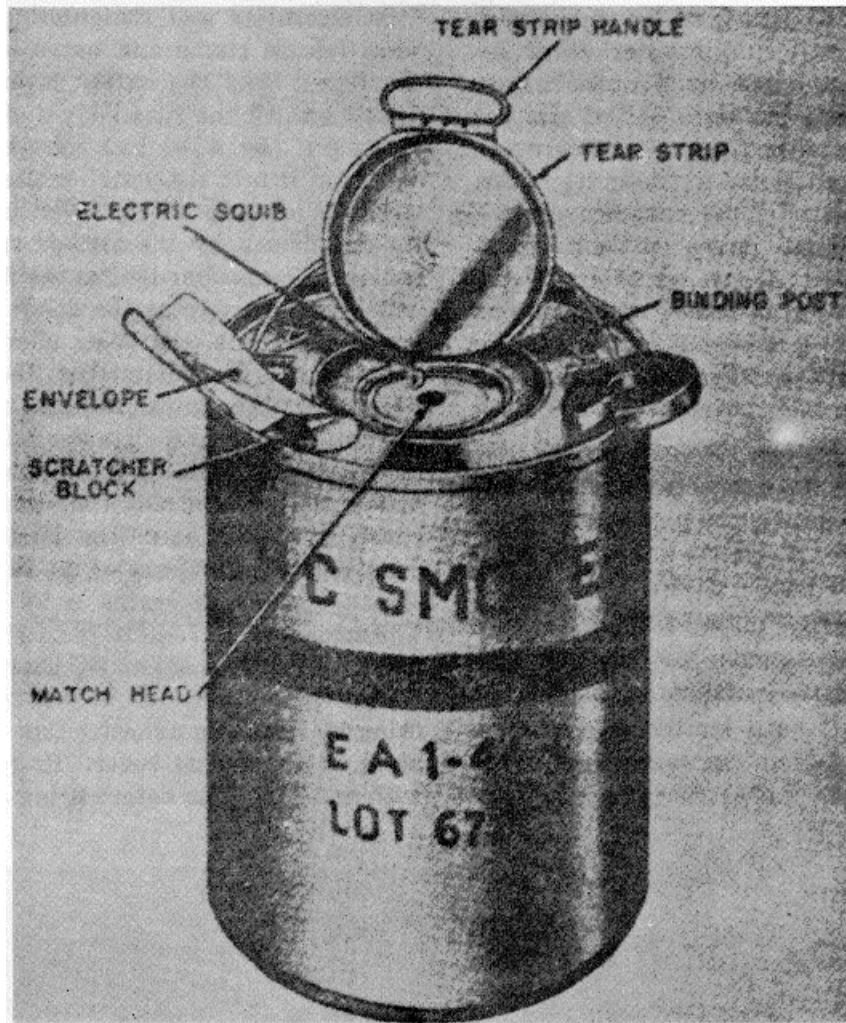

Figure 7. ABC-M5 smoke pot prepared for manual ignition.

posts. (It is not necessary to remove the tear strip when firing pots electrically.) When the electric circuit is completed, the squib ignites the matchhead which in turn ignites the starter mixture. The burning starter mixture ignites the HC filling which generates sufficient heat to soften the, solder holding the tear strip. Internal pressure blows off the tear strip allowing the smoke to escape. When firing the ABC-M5 smoke pot electrically, fire the pots from a position a short distance from the installation. A 6-volt source is required to ignite a number of smoke pots simultaneously, but a 1 1/2-volt flashlight battery can be used to ignite a single smoke pot. Use two batteries in series if the connecting wire is of higher resistance than the squib in the smoke pot. To ignite a pot in this manner, attach a wire not more than

10 feet long to each of the two binding posts of the smoke pot. Stretch the wires their full lengths being careful not to pull them from the binding posts and touch the free end of one wire to the center terminal of the battery and free end of the other wire to the base of the battery, closing the circuit.

10. Smoke Pot, Floating, HC, M4A2. a.
Description.

- (1) The M4A2 HC floating smoke pot (fig. 8) is a metal container, 12 inches in diameter by 13 inches high. The lower third of the pot contains approximately

27 1/2 pounds of HC smoke mixture. A waterproof outer cover secured to the pot by a quick-release clamp keeps moisture out of the pot and protects the fuze. A steel carrying handle is attached to the outer cover. A dish-shaped inner cover covers the filling and provides a mounting for a fuze adapter. Three ventholes in the inner cover are covered with adhesive tape. A steel handle is attached to the inner cover for carrying the smoke pot after the outer covers has been removed.

- (2) Starter mixture in a plastic cup is embedded in the smoke mixture. The filling is separated from the air chamber above by a plastic closure disk held in place by a metal retainer.
- (3) The M207A1 smoke pot fuze (fig. 9) is screwed into the fuze adapter in the inner cover. An igniter tube extends downward from the lower end of the fuze adapter to the starter mixture.

b. Operation and Functioning. Remove the quick-release clamp and outer cover, exposing the fuze. Hold the safety lever (fuze lever) firmly against the fuze body and withdraw the safety pin (fig. 10). Lift the pot by its handle and drop it into the water releasing the safety lever. When the safety lever is released, the striker, driven by the striker spring, hits the primer. The primer ignites the first-fire charge which in turn ignites the delay charge. After 1.2 to 2 seconds, the delay charge ignites the ignition charge, completing the fuze action. Flame from the ignition charge travels through the igniter tube to the starter mixture which in turn ignites the HC filling. Pressure builds up inside the pot and blows off the adhesive tape covering the vents in the inner cover. Total delay time from release of the safety lever until smoke production begins is 10 to 20 seconds. The smoke pot burns for 10 to 15 minutes.

Warning: Vent M4A2 HC floating smoke pots for at least 5 minutes within 24 hours before firing by removing adhesive tape from two ventholes in the inside cover. Recover the holes with adhesive tape before firing smoke pots.

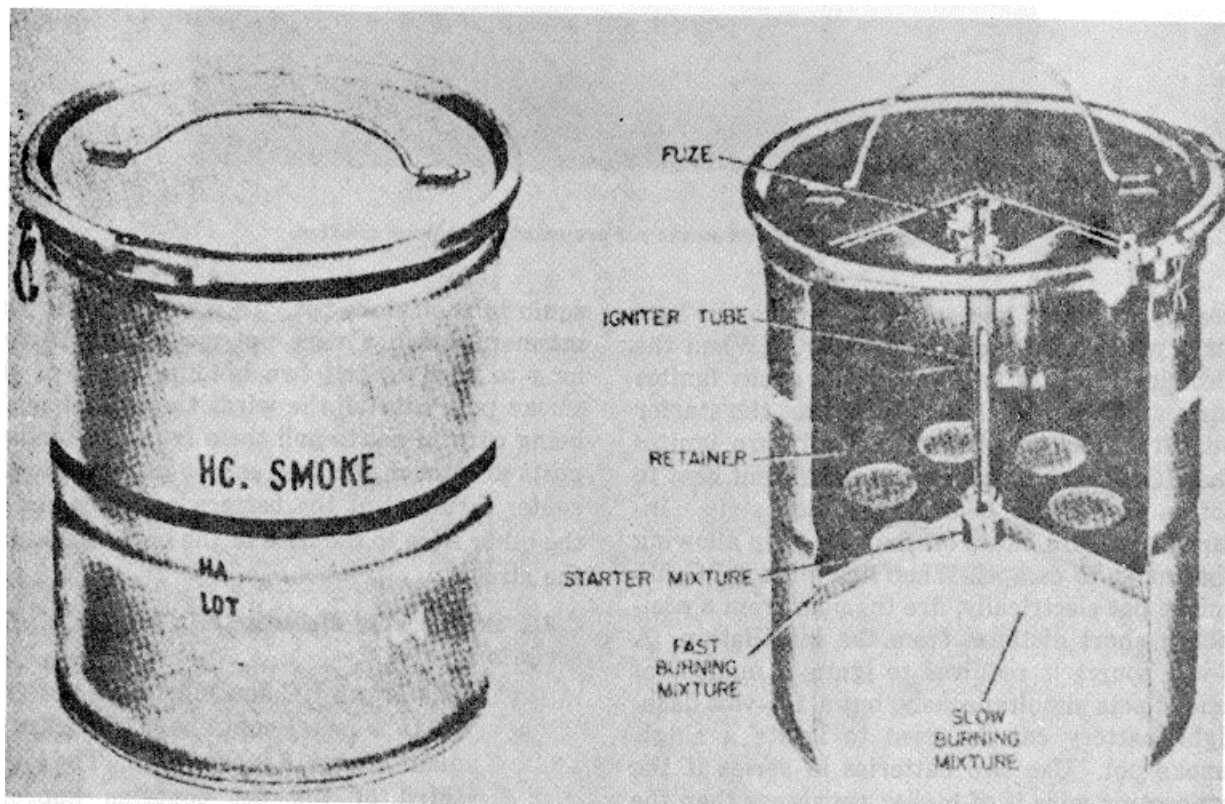

Figure 8. M4A2 HC floating smoke pot.

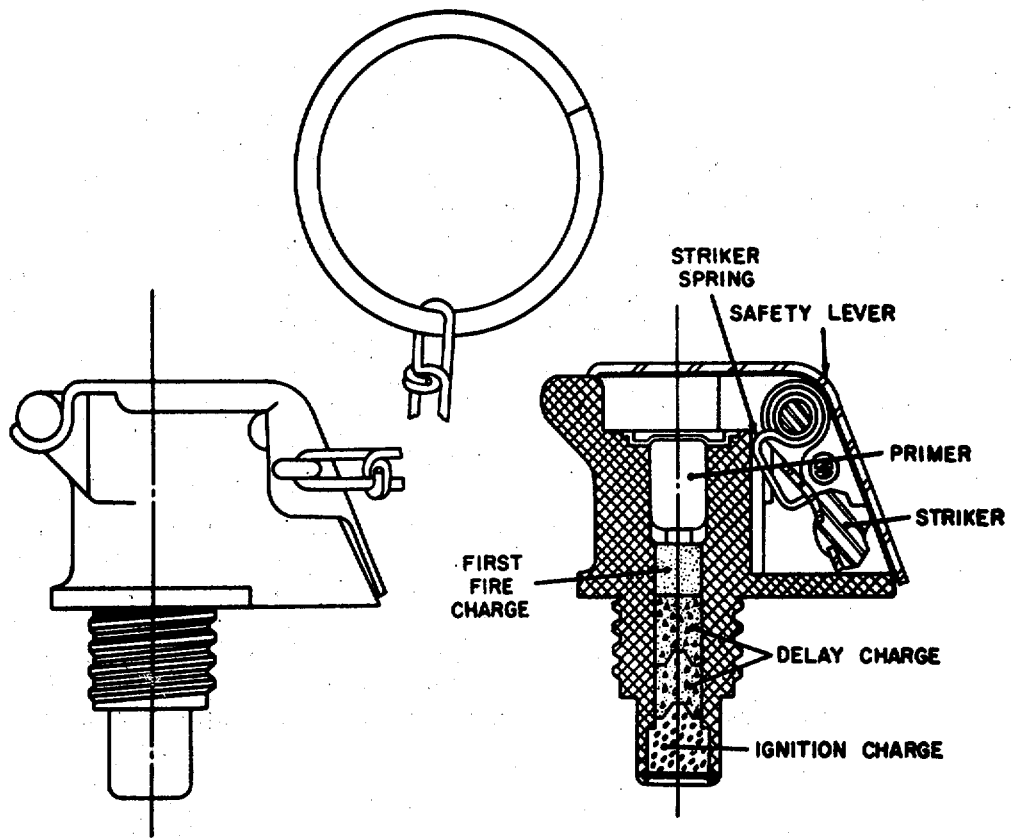

Figure 9. M207A1 floating smoke pot fuze.

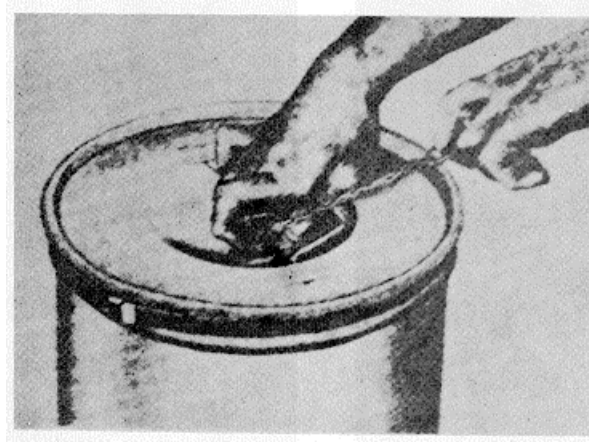

Figure 10. Firing the M4A2 HC floating smoke pot.

Section IV. THERMAL GENERATOR-TYPE SMOKE POTS

11. Smoke Pot, Floating, SGF2, AN-M7. *a. Body.* The body of the AN-M7 floating smoke pot (fig. 11) is a metal container 12 inches in diameter by 13 inches high. The upper portion of the body is rubbed; the base of the body is slightly tapered to facilitate stacking in storage. An outer cover with a carrying handle attached is fastened to the pot by a ring clamp. A dish-shaped inner cover (fig. 12) with a carrying handle attached is fastened to the body by lugs and steel strapping. A fuze adapter (2, fig. 13) in the center of the inner cover provides a seat for the fuze (18). Three ventholes, spaced equally around the fuze adapter, provide outlets for the smoke. When the pot is shipped, the ventholes are sealed with adhesive tape and a plastic plug (fig. 12) is screwed into the fuze opening in the adapter.

b. Interior (fig. 13). An air chamber (4) below the inner cover (3) occupies the upper third of the body. Three sinkholes (5), 1/8 inch in diameter, are cut in the side of the air chamber and are sealed with a low-melting-point solder (7). An oil chamber (8) directly below the air chamber is separated from it by an air partition (17). The oil chamber extends to the bottom of

the pot. A filling hole (14) in the side of the container, which is used when filling the pot with fog oil prior to use, is closed by a screwplug. Inside the oil chamber, a fuel chamber assembly, consisting of a fuel chamber (12), venturi tube (16), pressure tube (6), and oil feed tube (15), is crimped to the bottom of the body and sealed with a plastic compound. The fuel chamber contains a fuel block (9) consisting of a slow-burning fuel mixture covered by a thin layer of fast-burning fuel mixture. The fuel mixtures are composed of varying proportions of ammonium nitrate, charcoal, and wax. A doughnut-shaped ring of starter mixtures (10) is embedded in the top of the fuel block. The venturi tube extends from the top of the fuel chamber, through the oil chamber, and into the air chamber. The oil-feed tube is connected to the side of the venturi tube and extends to the bottom of the fog oil chamber, where it is covered by a screen (13). The point of connection between the oil-feed tube and the venturi tube is sealed with a low-melting-point solder seal (11). The pressure tube (6) is



Figure 11. AN-M7 SGF2 floating smoke pot.

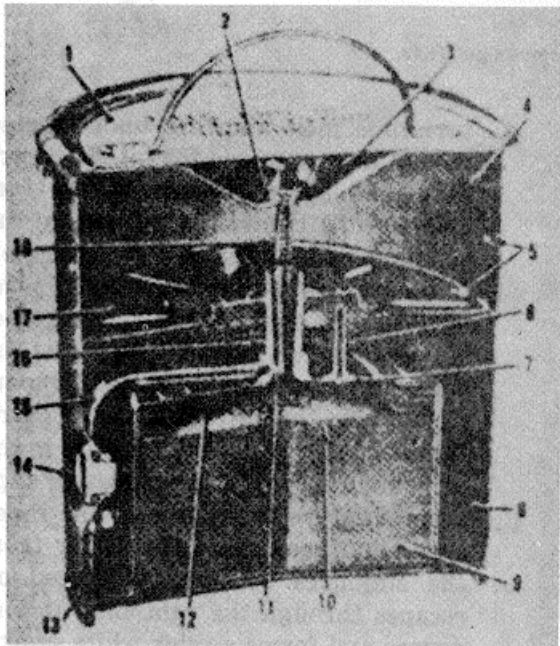

Figure 12. AN-M7 SGF2 floating smoke pot with outer cover removed.

connected to the top of the fuel chamber and extends above the surface of the oil in the oil chamber. The fuel chamber end of the pressure tube also is sealed with a low-melting-point solder seal (7).

c. *Fuzes.* Either an M208 floating smoke pot fuze (fig. 14) or an M209 electric floating smoke pot fuze (fig. 15) can be used to ignite the smoke pot.

12. Smoke Pot, Floating, SGF2, AN-M7A1. The AN-M7A1 SGF2 floating smoke pot is an improved version of the AN-M7 smoke pot. In addition to several internal improvements, such as the use of a threaded (not brazed-on) venturi which facilitates assembly and an improved fuel block, there is an additional sinkhole in the bottom on the AN-M7A1 smoke pot. All sinkholes are located so that water does not cool the solder seals as it sometimes does in the AN-M7 smoke pot.



- | | |
|-----------------|--------------------------|
| 1 Outer cover | 10 Starter mixture |
| 2 Fuze adapter | 11 Solder seal |
| 3 Inner cover | 12 Fuel chamber |
| 4 Air chamber | 13 Screen |
| 5 Sinkholes | 14 Filling hole and plug |
| 6 Pressure tube | 15 Oil-feed tube |
| 7 Solder seal | 16 Venturi tube |
| 8 Oil chamber | 17 Air partition |
| 9 Fuel block | 18 Fuze |

Figure 13. Components of AN-M7 SGF2 floating smoke pot.

13. Filling and Fuzing. Thermal generator-type (SGF) floating smoke pots are normally shipped to depots unfilled and unfuzed. Fog oil and fuzes are shipped separately.

a. The oil filling procedure may be varied depending on the available facilities and on the number of pots to be filled. When filling a large number of pots at one time, it may be desirable to connect several drums of oil to a filling manifold having a number of drawoff stations. In a smaller operation, oil may be drawn directly from a valve screwed into the end of an oil drum. See table I for the type of fog oil or mixture to be used at various temperatures.

b. When filling a pot with oil, leave the outer cover clamped on. Fill as follows:

- (1) Lay the pot on its side with the filling hole uppermost and place chocks at both sides to prevent the pot from rolling.
- (2) Remove the filling plug and asbestos gasket from the pot. Keep the gasket in place on the plug to prevent its loss.
- (3) Pour oil into the oil chamber to the level of the bottom of the fitting in the filling hole. Approximately 13 pounds of oil will fill the oil chamber to this level and will leave the necessary void.
- (4) Strew the filling plug and gasket in the filling hole and tighten the plug with a wrench.

c. To fuze the smoke pot, remove the ring clamp and outer cover, unscrew the plastic plug from the fuze adapter, and screw an M208 floating smoke pot fuze or an M209 electric floating smoke pot fuze handtight into the fuze opening in the adapter. Do not remove the tape covering the smoke-emission holes.

Warning: Do not use pull ring or safety pin on fuze for lifting or handling the pot.

14. Ignition. a. *On Water.* Hold the fuze safety lever on the M208 fuze firmly against the fuze body and withdraw the safety pin. Lift the pot by its handle and drop it into the water, releasing the safety lever.

b. *On Land.*

- (1) *Manual ignition.* Place the smoke pot in the desired location and withdraw

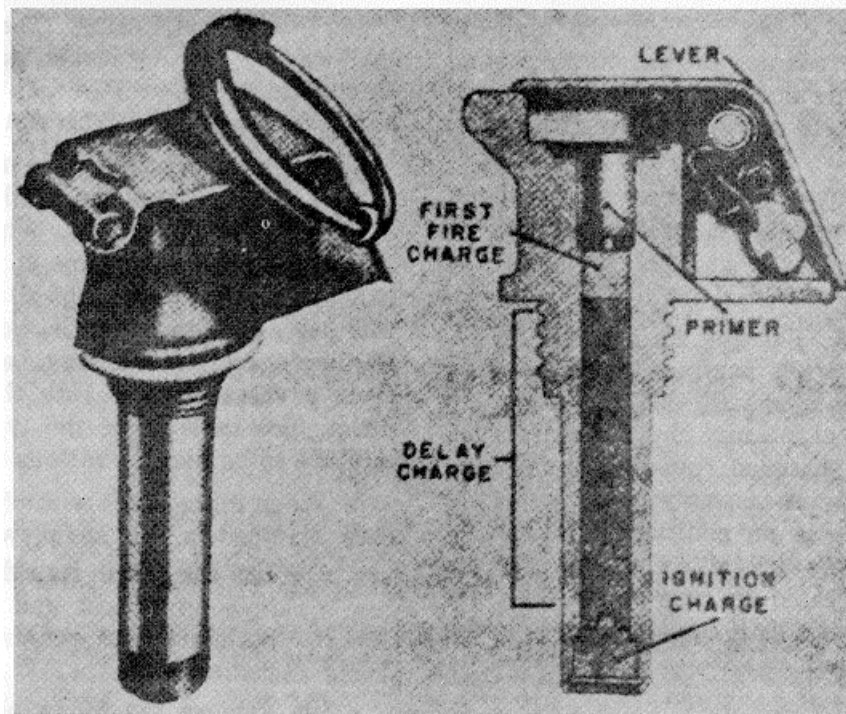

Figure 14. M208 floating smoke pot fuze.

the safety pin, releasing the safety lever.

- (2) *Electric ignition.* Only smoke pots equipped with an M209 electric floating smoke pot fuze can be ignited electrically. To ignite the pot electrically, connect the wires from the fuze to an electric firing circuit. When an electric current flows through the fuze, the fuze ignites.

15. Functioning. *a. With M208 Fuse.*

- (1) When the safety lever is released, the striker, driven by the striker spring, hits the primer which ignites. Flame from the primer travels through the first-fire charge and the delay charge and ignites the ignition charge, completing the fuse action.
- (2) Flame from the ignition charge passes down the venturi tube and ignites the starter mixture which ignites the fuel block. Hot gases from the burning fuel block pass upward through the venturi tube into the air chamber. The solder seals in the pressure tube and the venturi tube melt allowing unobstructed flow

of hot gases and fog oil. Pressure developed by hot gases in the fuel chamber is transmitted through the pressure tube to the surface of the oil in the oil chamber and forces oil up the oil-feed tube and into the venturi tube. Hot combustion gases rushing past the constriction of the venturi tube vaporize oil from the oil-feed tube and carry it into the air chamber. Pressure in the air chamber blows the adhesive tape from the three ventholes in the inner cover and heat melts the solder from the sinkholes. As the vaporized oil escapes through the ventholes, it condenses and forms a thick white smoke. Smoke production begins from 8 to 20 seconds after the fuze safety lever is released and continues for 8 to 13 minutes. While the fuel block is burning, pressure is maintained inside the pot and water is prevented from entering through the sinkholes. When the fuel is consumed, pressure inside the pot falls to atmospheric pressure and water

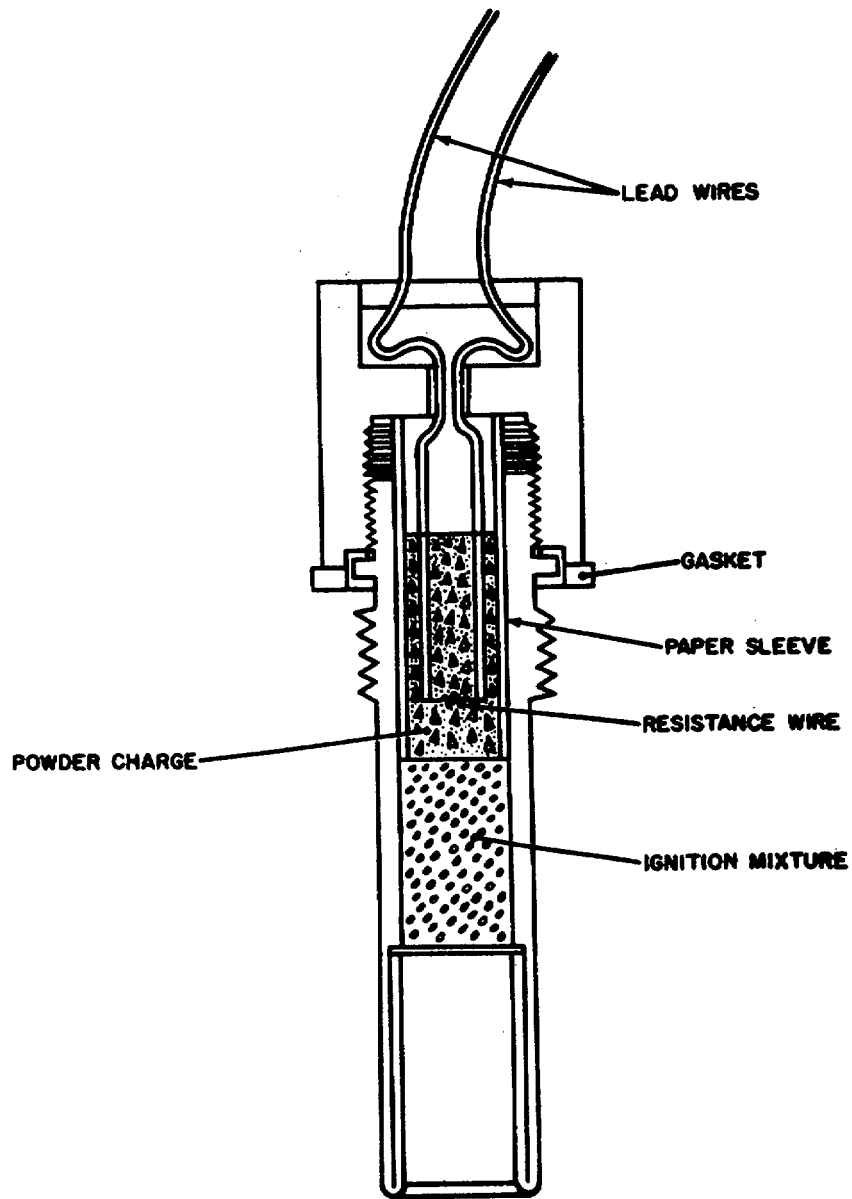

Figure 15. M209 electric floating smoke pot fuze.

enters through the sinkholes, causing the pot to sink.

b. With M209 Fuze. Current flowing through the resistance wire in the fuze heats the wire which ignites the powder charge. The powder charge ignites the

ignition mixture, completing the fuze action. Flame from the fuze passes down the venturi tube and ignites the starter mixture in the fuel block. The smoke pot then generates smoke in the same way as when ignited by the M208 floating smoke pot fuze.

AGO 8556A

Section V. MARKING AND PACKING

16. Marking. *a. Body Color.* The bodies of smoke pots manufactured before mid-1962 are gray; the bodies of smoke pots of later manufacture are light green.

b. Markings. Smoke pots manufactured before mid-1962 are marked with one yellow band and with the symbol for the filling, the date of filling, the manufacturer's lot number, and any other pertinent

information in yellow. Smoke pots of later manufacture have no band and the symbol for the filling and other pertinent information are marked in black on the light green body.

17. Packing. The smoke pots are packed for shipment as indicated in table II.

Section VI. SHIPMENT, STORAGE, AND DEMOLITION TO PREVENT ENEMY USE

18. Shipment. Smoke pots are shipped as described in table II. Army regulations and Interstate Commerce Commission regulations govern the shipment of chemical munitions within the zone of interior. Oversea shipments should be made in compliance with instructions contained in SR 55-730-10 and TM 3-250.

19. Storage. Smoke pots are classified for storage purposes as Group D (incendiary and readily flammable) chemical munitions. Detailed instructions for storing smoke pots are found in TM 3-250.

20. Firefighting. Firefighters in areas containing smoke pots should confine their efforts to preventing fires from spreading in magazine areas or storage areas. Fires in igloo-type or Corbetta-type magazines will not be fought. Fires of HC mixtures must be deluged with water, because small volumes of water are ineffective and may increase the fire.

21. Demolition to Prevent Enemy Use. *a.* When smoke pots are in danger of being captured by an enemy, the decision to destroy them must be made by the responsible commander.

b. Destroy HC smoke pots by burning them or by mechanical means.

(1) *Burning.* Pile the munitions with all available flammable material such as brush or dunnage, pour gasoline over the pile, and ignite it from a safe distance.

Warning: Be sure that the smoke produced by burning HC does not interfere with operations of nearby tactical units

(2) *Mechanical means.* Puncture containers with tools or small arms fire and wet the filling.

c. Destroy filled thermal-generator smoke pots by burning them. Destroy empty thermal-generator smoke pots by puncturing the oil chamber with tools or small-arms fire.

By Order of the Secretary of the Army:

EARLE G. WHEELER,
*General, United States Army,
Chief of Staff.*

Official:

J. C. LAMBERT,
*Major General, United States Army,
The Adjutant General.*

Distribution:

Active Army:

CNGB (1)
USA Maint Bd (2)
USACBRCA (2)
USAADCDA (2)
USAARMCA (2)
USAARTYCA (2)
NSAAVNCA (2)
USAICDA (2)
USASWCDA (2)
USAARMC (2)
USAAMC (2).
USA Engr Cen (2)
USA GM Cen (2)
USAIC (2)
USCONARC (10)
ARADCOM (5)
ARADCOM Rgn (5)
OS Maj Comd (5)
Armies (5)
Corps (3)
Div (3)
Regt/BG (1)
USMA (10)
Svc Colleges (10)

Br Svc Sch (10) except
USACMLSCH (50)
GENDEP (OS) (5)
Dep (OS) (5)
A Dep (5)
USASMCOM (1)
USAMUCOM (5)
USAMC (5)
POE (1)
Instl (2)
USA Trans Tml Comd (1)
Army Tml (1)
USAOSA (2)
Arsenals (8) except
Edgewood (50)
CML Proc Dist (8)
PG (5)
USA Corps (1)
Units org under fol TOE:
(1 copy each)
3-7
3-67
3-117
3-147
3-266
3-267

NG: State AG (3); units-same as active Army except allowance is one copy to each unit.

USAR: Same as active Army except allowance is one copy to each unit.

For explanation of abbreviations used, see AR 32060.

AGO 8556A

*U.S. GOVERNMENT PRINTING OFFICE: 1994 - 360-421/82799

